

OPERATING INSTRUCTIONS & SERVICE MANUAL

SOLID-STATE STEREO AMPLIFIER

SANSUI AU-222



Sansui

SANSUI ELECTRIC CO., LTD.

Congratulations, you are now the owner of a new Sansui AU-222 control amplifier manufactured by Sansui, the world's foremost audio-only specialist.

The AU-222 incorporates many of state-of-the-art features of the more powerful Sansui AU-555, including an all silicon solid state design, professional arrangement of controls and a satin-black control panel. Like all other AU series amplifiers, the AU-222's tonal quality has been perfected and proved not only by precision electronic measuring instruments, but also by repeated listening tests in a wide variety of environments.

This manual has been prepared to guide you in operating and caring for your AU-222 correctly. Please read it carefully and retain for future reference.

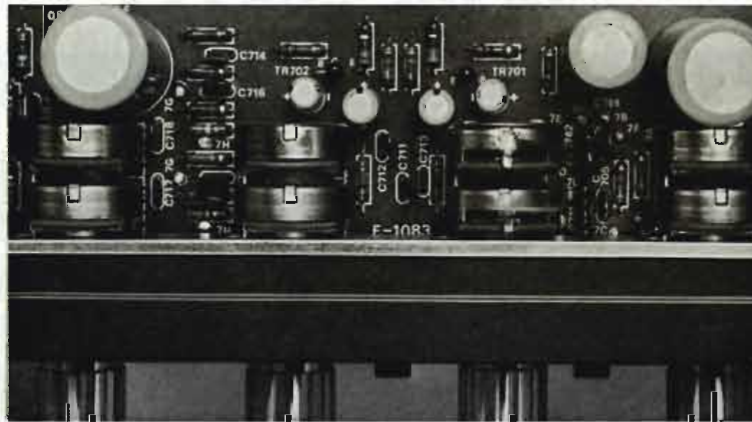

CONTENTS

OPERATING

Switches and Controls	3, 4
Operations	
Speakers/Record Players	5, 6
Tape Recorders/Tape Deck	7, 8
Tuners	9
Maintenance.....	10, 11, 12
Specifications/Characteristics	13, 14

SERVICE MANUAL

Schematic Diagram	15, 16
General Troubleshooting Chart	17, 18
Parts Layout.....	19
Disassembly Procedure	20
Custom Mounting	21, 22
Main-AMP. Alignment.....	23, 24
Printed Circuit Sheets and Parts List.....	25, 26, 27, 28
Other Parts and their Position on Chassis	29, 30



POWER

BASS

TREBLE

VOLUME

BALANCE

SELECTOR

HEAD PHONES

LOW FILTER HIGH FILTER LOUDNESS MODE TAPE MONITOR

ON OFF ON OFF ON OFF MONO PLAY BACK

Sansui
STEREOPHONIC AMPLIFIER
SOLID STATE
AU-222

SWITCHES AND CONTROLS

Volume Control Knob

This control adjusts the overall sound level of both channels. As the control is turned clockwise, the volume is increased.

Treble Control Knob

This control is used to boost or to cut the high-end response, according to personal taste, speaker response, and listening conditions. With the control in the mid-position (marked 0), the treble tones will sound exactly as recorded or broadcast. To emphasize the treble, turn it clockwise. To decrease the intensity of the treble tones, turn it counterclockwise.

Bass Control Knob

This control is used to boost or to cut the low-end response in a fashion similar to that of the TREBLE Control.

Power Indicator

The indicator lamp glows when the POWER switch is pushed ON. It remains lit while the amplifier is in operation.

Power Switch

When this switch is pushed on, power is applied to the amplifier and to any component connected to the AC outlet marked SWITCHED on the rear panel of the unit. To shut off the power, push the switch again.

Headphones Jack

This jack accommodates headphones for monitoring or private listening. It will accept any standard phone plug, but stereo headphones of dynamic design are recommended for use. When the headphones are plugged in, the speakers are automatically cut out to provide the convenience of private listening.



Low Filter Switch

Such low-frequency noise as turntable rumble is removed or reduced by turning this switch to the ON position.

High Filter Switch

This switch is used to eliminate or reduce high-frequency noise such as surface noise from old or worn records, tape hiss and radio noise caused by interference from nearby electrical appliances.

Loudness Switch

This switch is used to boost bass and treble response at low volumes. Due to the sensitivity of human hearing, both bass and treble seem greatly reduced at low listening levels. This switch compensates for this apparent loss.



Balance Control Knob

This control is used to adjust for equal sound from both left and right channels when slight imperfections in program material, variations in speaker output and the vagaries of room acoustics make this procedure necessary. Turning the control clockwise accents the right channel by reducing the left channel output.

Mode Switch

STEREO—Use this position for all stereophonic programs.

MONO—Use this position for all monophonic programs. The MODE switch in the MONO position connects either right or left, or both right and left programs to both speakers.

Selector Switch

This switch selects from among the various program sources connected to the amplifier input jacks.

TAPE HEAD—Selects a tape deck (with a speed of $7\frac{1}{2}$ ips) connected to the TAPE HEAD jacks on the rear of the amplifier.

PHONO 1—Selects a record player using a 47 k ohms cartridge connected to the PHONO 1 inputs on the rear panel.

PHONO 2—Selects a record player using a 100 k ohms cartridge connected to the PHONO 2 inputs on the rear panel.

AUX 1—Selects a tuner, MPX adaptor or other component connected to the AUX 1 inputs on the rear panel.

AUX 2—Selects a tuner, MPX adaptor or other component connected to the AUX 2 inputs on the rear panel.

Tape Monitor Switch

This switch enables you to compare the recorded tape with the program source. When the switch is in the SOURCE position, the program source is heard from the speakers. When the switch is in the PLAYBACK position, the recorded tape is heard from the speakers. Tape monitoring is possible only with 3-head tape recorders, i.e., those with separate playback and recording heads.

IMPORTANT: When the TAPE MONITOR switch is in the PLAYBACK position, signals from any other source will not be heard from the speakers. When not monitoring, make sure the switch is in the SOURCE position.

ERROR: undefined
OFFENDING COMMAND: ~

STACK:

OPERATIONS

SPEAKERS / RECORD PLAYERS

Loudspeakers

Connection

Any 4-8-16-ohm speakers can be used with the AU-222.

1. Connect the (+) terminal of the speaker on your right (as viewed from the front of the amplifier) to the RIGHT SPEAKER (+) terminal on the rear panel of the amplifier.
2. Connect the (-) or common terminal of your speakers to the RIGHT SPEAKER (-) terminal on

the rear panel.

3. Connect the (+) terminal of the left speaker to the LEFT SPEAKER (+) terminal on the rear panel.

4. Connect the (-) or common terminal of the left speaker to the LEFT SPEAKER (-) terminal on the rear panel.

After connecting the speakers to the amplifier, make sure the speaker cables are secured tightly at the terminals. Special care should be taken that the wires are not shorted between the (+) and (-) termi-

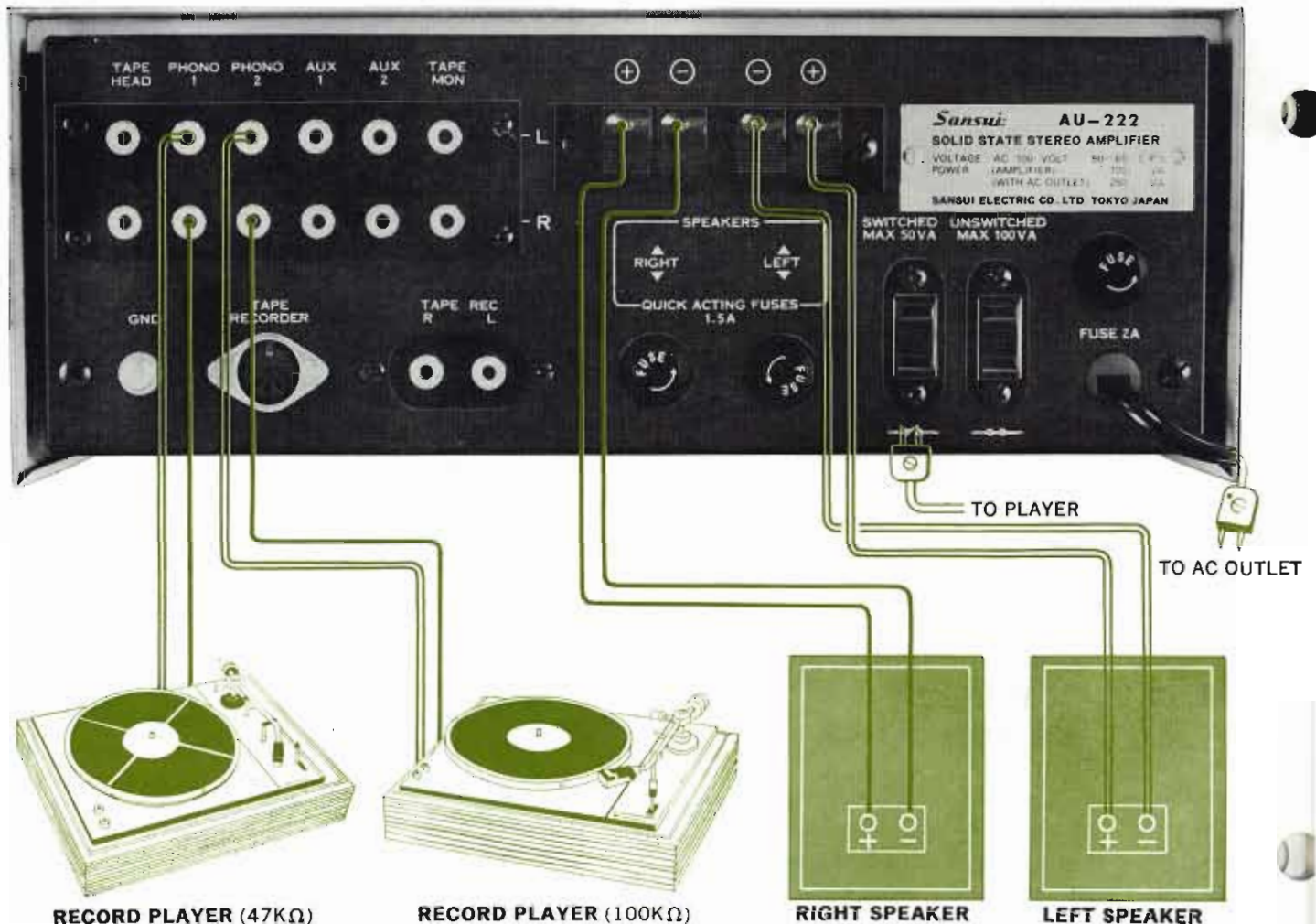

nals. If shorted, the fuse may blow out and the amplifier may become damaged.

Phasing of Speakers

If the polarities (+ and -) of the speakers and the amplifier are not matched correctly, sound cancellation at some frequencies or in some listening position occurs. Particularly when listening to monophonic reproduction, this condition is noticeable by an absence of sound at a point midway between right and left speakers. If this situation occurs, check the amplifier and speaker connections one more and reverse the connections between the amplifier and either right or left speaker.

Record Players

Connection

The following procedures are recommended for use with a record player or turntable utilizing a magnetic cartridge:

1. Connect the left channel output of a stereo turntable to the LEFT PHONO input jack on the rear panel of the amplifier.
2. Connect the right channel output of the turntable to the RIGHT PHONO input jack.
3. If a monophonic player or turntable is used, it may be connected to either RIGHT or LEFT PHONO input jack.
4. Insert the power-cord plug of the player into the AC outlet marked SWITCHED on the rear of the amplifier. The power supply for the player will then be controlled by the POWER switch on the front panel of the amplifier.

NOTE: Although it is not recommended from a standpoint of tone quality, if a record player using a crystal or ceramic cartridge must be used, connect the outputs of the player the AUX jacks on the rear of the amplifier.

Operation

1. Set the SELECTOR switch to the PHONO 1 or PHONO 2 position, depending on which cartridge is being used.
2. Set the MODE switch to the STEREO position. If a monophonic record player is used, set MODE switch to MONO.
3. Turn the player's power on, and select the correct speed for the record(s) to be played.
4. Place the needle on the record. When monophonic records are played on a stereo player, follow the same procedures as for stereophonic records for better results.
5. Adjust the BALANCE control to obtain equal sound from both right and left channels.
6. Use all other controls and switches according to taste and listening conditions.

Humming and Howling

Care must be taken never to place a record player on or too near a speaker enclosure. Otherwise the vibration of the speaker enclosure is transmitted to the player and causes howling. It is best to keep these components completely separated, but if this is impossible, to place a thick cushion between them. Humming is a phenomenon caused by incomplete or incorrect player-amplifier connections. If this occurs, check to make sure that all connections are complete and that the thickness of the connecting wire is sufficient.

OPERATIONS

—TAPE RECORDERS / TAPE DECK

Tape Recorders and Deck

Tape recorders can be connected to record from, and playback through, the amplifier. A tape deck without playback pre-amplifier can be connected to play back through the set. Tape monitoring is possible with a tape recorder having a separate playback pre-amplifier as well as separate recording and playback heads.

Tape Deck Connections

To connect a tape deck without a built-in playback pre-amplifier:

1. Connect the left channel output of the tape deck to the LEFT TAPE HEAD input on the rear of the amplifier.
2. Connect the right channel output of the tape deck to the RIGHT TAPE HEAD input.
3. If a monophonic tape deck is used, it may be connected to either RIGHT or LEFT channel.

Tape Deck Operations

1. Set the SELECTOR switch TAPE HEAD position.
2. Turn on the power supply for the tape deck.
3. If a monophonic tape deck is used, set the MODE switch to the MONO position.
4. Adjust the BALANCE control to obtain equal sound from both right and left channels.
5. Use all other controls and switches according to taste and listening conditions.

Tape Recorder Connections

DIN Plug Tape Record

If your tape recorder has a DIN (German Industrial Standard) 5-pin plug, plug into the TAPE RECORDER socket located near the lower left corner on the rear panel of the amplifier.

Pin Jack Tape Recorder

Connect the left and right channels of the record-

ing input cord of the tape recorder to the LEFT and RIGHT TAPE REC jacks respectively. Then connect the left and right output channels of the play back cord to the LEFT and RIGHT TAPE MON jacks respectively.

Tape Recorder Operations

To record on tapes from the amplifier:

1. Set the SELECTOR switch to the program to be recorded.
2. Set the MODE switch to the STEREO position. If a monophonic tape recorder is used, set the switch to MONO.
3. Operate the tape recorder for recording.
4. Use all other controls and switches according to taste and listening conditions.

To play back through the amplifier:

1. Set the TAPE MONITOR switch to the PLAYBACK position.
2. Operate the tape recorder for playback.
3. Use all other controls and switches according to taste and listening conditions.

Tape Monitoring

Tape monitoring is possible only with a 3-head tape recorder which has a separate playback pre-amplifier as well as separate recording and playback heads. Set the TAPE MONITOR switch to the PLAYBACK position and use all other controls and switches according to taste and listening conditions.

NOTE:

1. Tape recorded sound cannot be controlled by the switches and controls on the front panel of the amplifier. They control sound from the speakers only.
2. For better results, record directly through the AU-222, rather than through microphones placed

in front of the speakers.

3. Tape recorders referred to in this section include only those with built-in playback preamplifiers. Those without should be connected and operated as tape decks.

4. The TAPE MONITOR switch should be in the

SOURCE position except when the tapes are being monitored or played back by the tape recorder. When the switch is in the PLAYBACK position, signals from any other source will not be heard from the speakers.

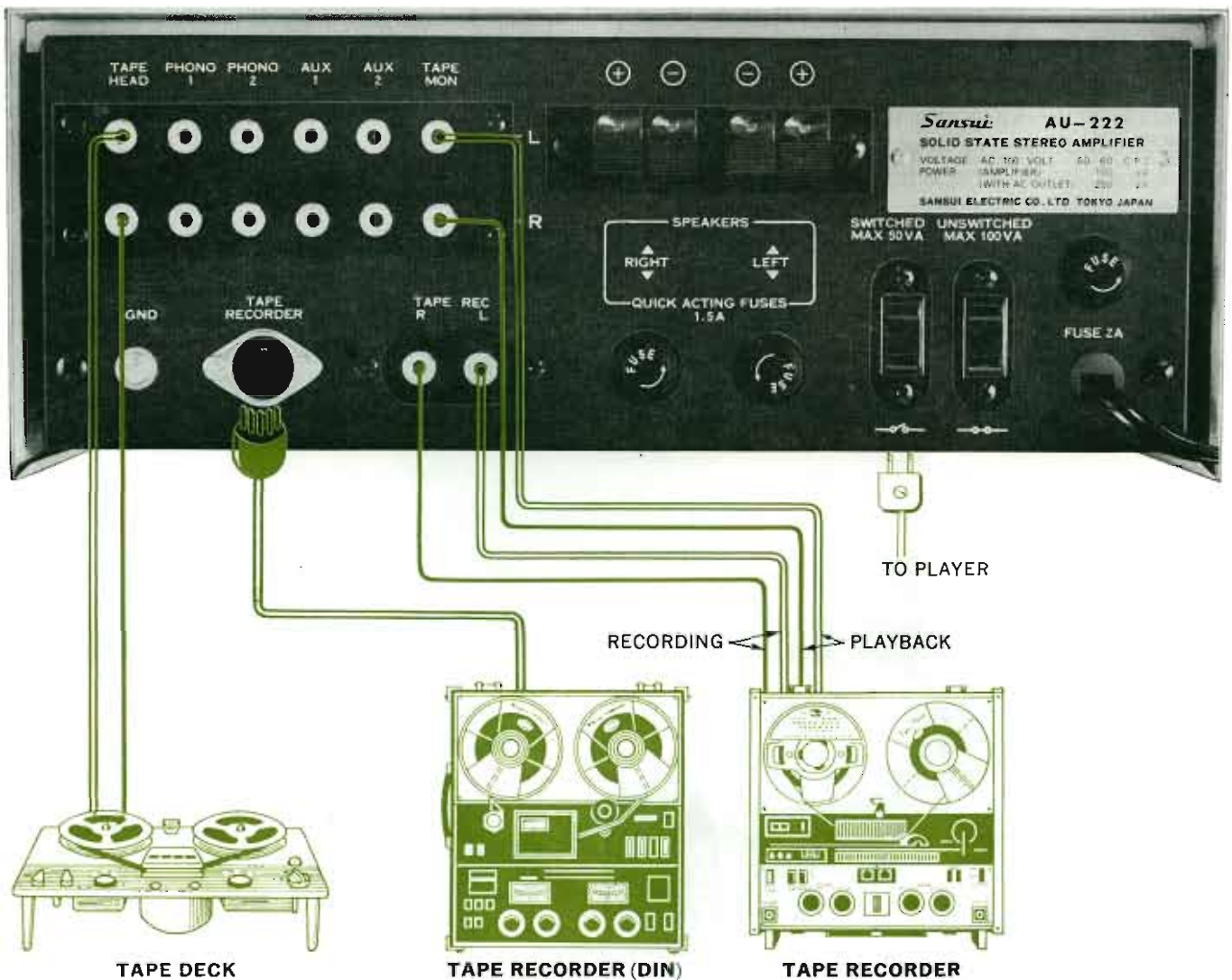

OPERATIONS

TUNERS

Listening to a Stereo FM Program

1. Set the FUNCTION selector switch to AUX 1 or AUX 2 depending on the input jacks to which a stereo tuner is connected.
2. Set the MODE switches to STEREO.
3. Select the desired station with the tuner.
4. Adjust the amplifier's front panel controls and switches according to taste and room acoustics.

Listening to a Monophonic Program

1. Set the FUNCTION selector switch to AUX 1 or AUX 2 depending on the input jacks to which a monophonic tuner is connected.
2. Set the MODE switches to MONO.
3. Select the desired station with the tuner.
4. Adjust the amplifier's front panel controls and switches according to taste and listening conditions.

Listening to a Stereo FM Program with a FM-MPX Adaptor

1. Set the FUNCTION selector switch to AUX 1 or AUX 2 depending on the input jacks to which a tuner and a FM-MPX adaptor are connected.
2. Set the MODE switches to STEREO.
3. Select the desired station with the tuner.
4. Set the FM-MPX adaptor to STEREO.
5. Adjust the amplifier's front panel controls and switches according to taste and room acoustics.

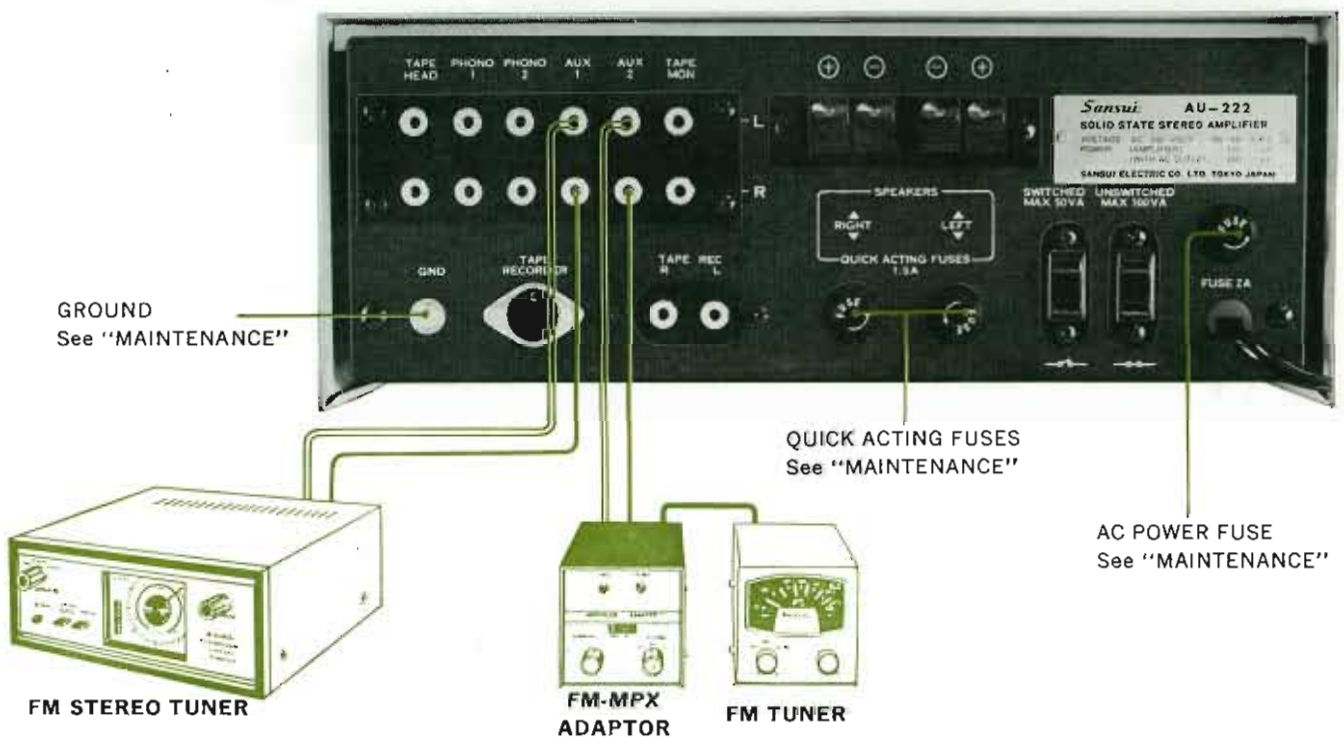

MAINTENANCE

Quick-Acting Fuses

The AU-222 is provided with the double protective device for expensive power transistors: quick-acting fuses in addition to the ordinary power limiter. If, after the POWER switch is pushed on and the power indicator lights up, neither channel operates or only one operates normally, is either because one or both quick-acting fuses have blown. In this case, remove the AU-222's power supply cord from its outlet, screw out the fuse holders on the rear panel, and check to see if the fuses are blown. If the fuses are faulty, replace them with identical AGB 1.5A fuses (supplied) after finding and eliminating the source of trouble that caused them to blow.

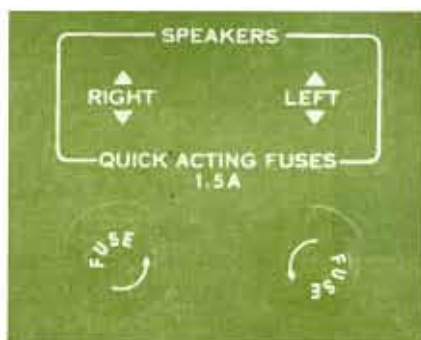

Power Fuses

Should the amplifier fail to operate and the power indicator fail to light up when the POWER switch is pushed ON, the probable cause is either a power stoppage or a blown fuse. To check, remove the AU-222's power supply cord from its outlet, turn the fuse holder on the rear panel counterclockwise, and remove the fuse. If it is blown, replace it with a new glasstube fuse of the same capacity (2 amperes) after determining and eliminating the trouble source that caused the fuse to blow. Using wire or a fuse of a different capacity as a stop-gap measure is dangerous and should be avoided.



AC Outlets

Two outlets on the rear panel provide AC connection for additional components. One is controlled by the POWER switch on the front panel and the other is not switched. The switched outlet is used for powering a tuner and the unswitched is for a record player or turn table. The maximum rating of the outlets is 50 and 100VA respectively.



MAINTENANCE

Hum and Howling

If, when using a tape recorder or record player, unpleasant humming or howling is heard, it is usually a result of the following:

The record player is placed on or near the speaker box causing sound waves to be transmitted from the speaker to the player (howling). To prevent this, place the record player away from the speaker box or put a thick cushion between the two components.

A low buzzing sound will also be produced if adequately thick shieldwire is not used for connections, or if connections have not been properly made. Be sure that the shieldwire is properly soldered to the pin-plugs as illustrated in "Connecting Wire", and that the motor and pickup arm or the record player are properly grounded.

Wire Connections

When connecting tape recorders, record players or other components to the AU-222, be sure to use shielded wire. The use of an ordinary cord or vinyl wire may cause humming and buzzing. The length of the shielded wire used should be shorter than 5 feet. Be sure that all lead wires between the amplifier and components are properly connected. If the connections are loose or in touch with other parts,

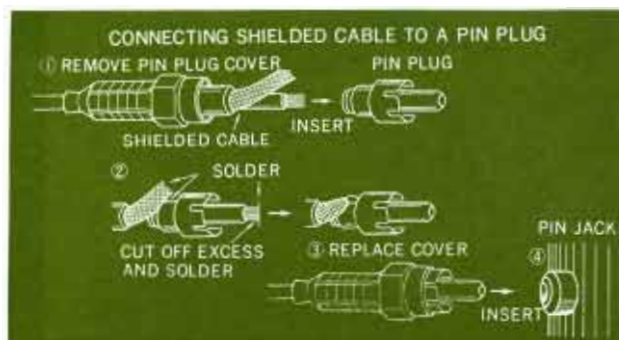

the amplifier will not function properly, may pick-up noise, and even break down over a period of time.

System Grounding

Connect one end of vinyl or enameled wire to the GND screw on the rear panel and the other end to a copper plate buried underground or water pipe, in order to eliminate the possibility of hum. To ground an entire audio system, connect the grounding wire of each component used to this terminal.

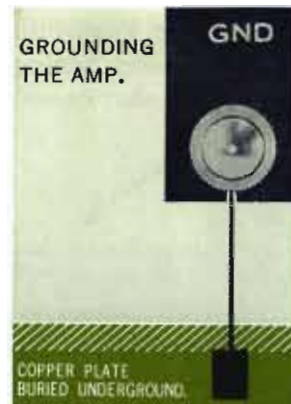

Installation

The AU-222 may be mounted in a custom built installation by following the directions and illustration by following the directions and illustrations in this manual. It is important to remember that adequate circulation of air is absolutely essential for proper operation. See page 21.

Voltage Selector Plug

This plug is located inside the bonnet of the amplifier and has been set to the voltage of your area prior to shipment. If the amplifier is ever moved to an area with another voltage requirement, this plug must be changed to the proper voltage of the new area. To change, remove the bonnet from the amplifier, remove the plug from the voltage socket you have been using, and plug the arrow head into the appropriate voltage requirement of 100, 117, 220 and 240 volts.



Location

Transistors are relatively susceptible to heat. Although proper ventilation for cool running is one of the design considerations of the AU-222, some simple precautions are necessary:

1. If the amplifier is installed in a cabinet, leave sufficient open space on all three sides of the unit for adequate ventilation.
2. If the amplifier is installed on an open shelf without a cabinet, keep it out of direct sunlight.

Where to Place

Since transistors are extremely susceptible to heat, the AU-222 has been designed to diffuse heat through the top and rear of its case. Therefore, special consideration should be given to where it will be used before installing the tuner. It should not be operated in a place where it is exposed directly to the sun, near radiators or other heat-

generating sources, and it should never be mounted in an air-tight cabinet. Finally nothing should be placed on top of it.

Phasing

The right and left speakers must be properly phased. The speakers for the two channels must push the sound wave out together. If one pushes while the other pulls, there is sound cancellation at some frequencies or in some listening locations. Incorrect phasing is evidenced by loss of bass when you are listening to a monophonic record on a stereo record player at a point midway between the two speaker systems. If incorrect, reverse the speaker connections (+ and -) of either speaker system.

SPECIFICATIONS / CHARACTERISTICS

POWER OUTPUT

MUSIC POWER (IHF): 46W at 8 ohms
MUSIC POWER (IHF): 40W at 4 ohms
CONTINUOUS POWER (each channel):
18/18W at 8 ohms
16/16W at 4 ohms

HARMONIC DISTORTION: Less than 0.8%

INTER MODULATION DISTORTION
(60 Hz; 7,000 Hz=4:1) Less than 1%

POWER BANDWIDTH (IHF):
from 20 to 20,000Hz at 8 ohm

FREQUENCY RESPONSE: from 20 to 30,000 Hz

CHANNEL SEPARATION: better than 50dB

OUTPUT IMPEDANCE: from 4 to 16 ohms

DAMPING FACTOR: greater than 20 at 8 ohm

HUM AND NOISE (IHF):

VOLUME AT MINIMUM: better than 80dB
PHONO: better than 60dB
AUX: better than 65dB

INPUT SENSITIVITY (for rated output):

PHONO 1: 2 mV (47 k ohms)
PHONO 2: 2 mV (100 k ohms)
TAPE HEAD (7½ ips): 1.5 mV (200 k ohms)
AUX 1: 150 mV (100 k ohms)
AUX 2: 150 mV (100 k ohms)
TAPE MONITOR: 150 mV (40 k ohms)

RECORDING OUTPUT

Pin: 150 mV
DIN: 30 mV

CONTROLS AND SWITCHES

BASS CONTROL: +10dB to -10dB at 50 Hz
TREBLE CONTROL: +12 to -14dB at 10,000Hz
LOUDNESS CONTROL: +8dB at 50Hz, +3dB at
10,000Hz (Volume control at
-30dB)

LOW FILTER: -10dB at 50Hz
HIGH FILTER: -11dB at 15,000Hz
MODE: 1) STEREO 2) MONO (L+R)
SELECTOR: 1) TAPE HEAD 2) PHONO 1
3) PHONO 2 4) AUX 1
5) AUX 2

OTHER SPECIAL FEATURES

Direct tape monitor. Head phone jack.
DIN connector.

TRANSISTORS AND DIODES

TRANSISTOR: 18
DIODE AND VARISTOR: 4

POWER REQUIREMENTS

POWER VOLTAGE: 110, 117V, 220 and 240V,
50~60Hz.

POWER CONSUMPTION: 20VA at zero signal
100VA at max. signal

DIMENSIONS

WIDTH: 292mm (11½")
HEIGHT (Excluding rubber stand): 111mm (4¾")
DEPTH (Excluding knob): 267mm (10½")

WEIGHT

WEIGHT: 5.8kg (12⅜ lbs)

MUSIC POWER

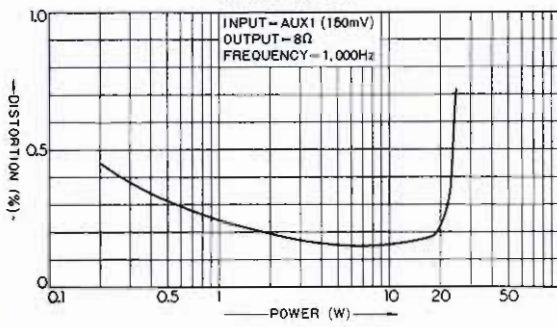

HARMONIC DISTORTION

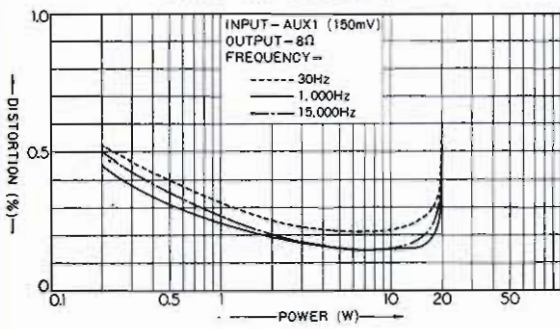

SCHEMATIC DIAGRAM

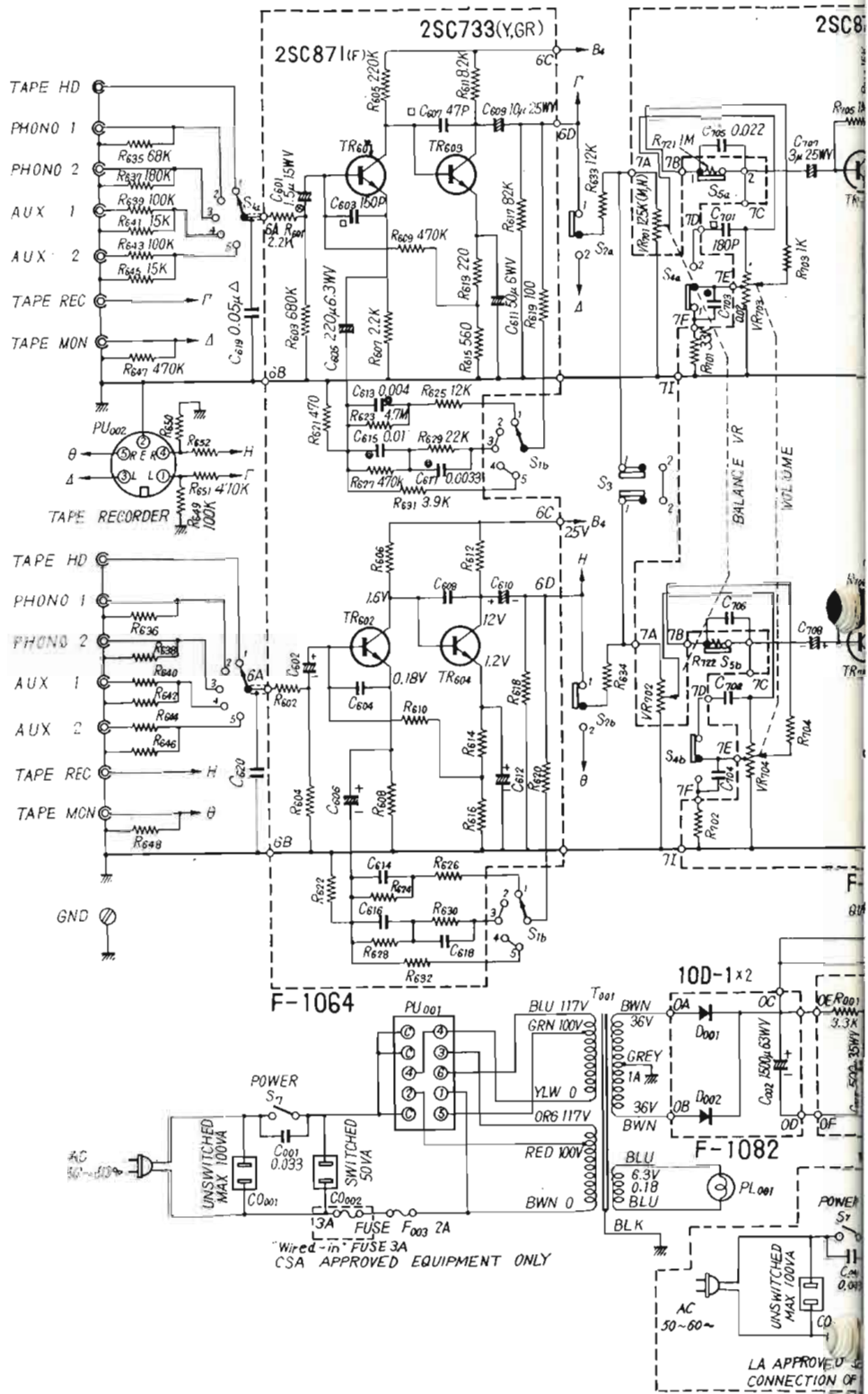

LAST	
R652	C620
R724	C722
R645	C620
R003	C005

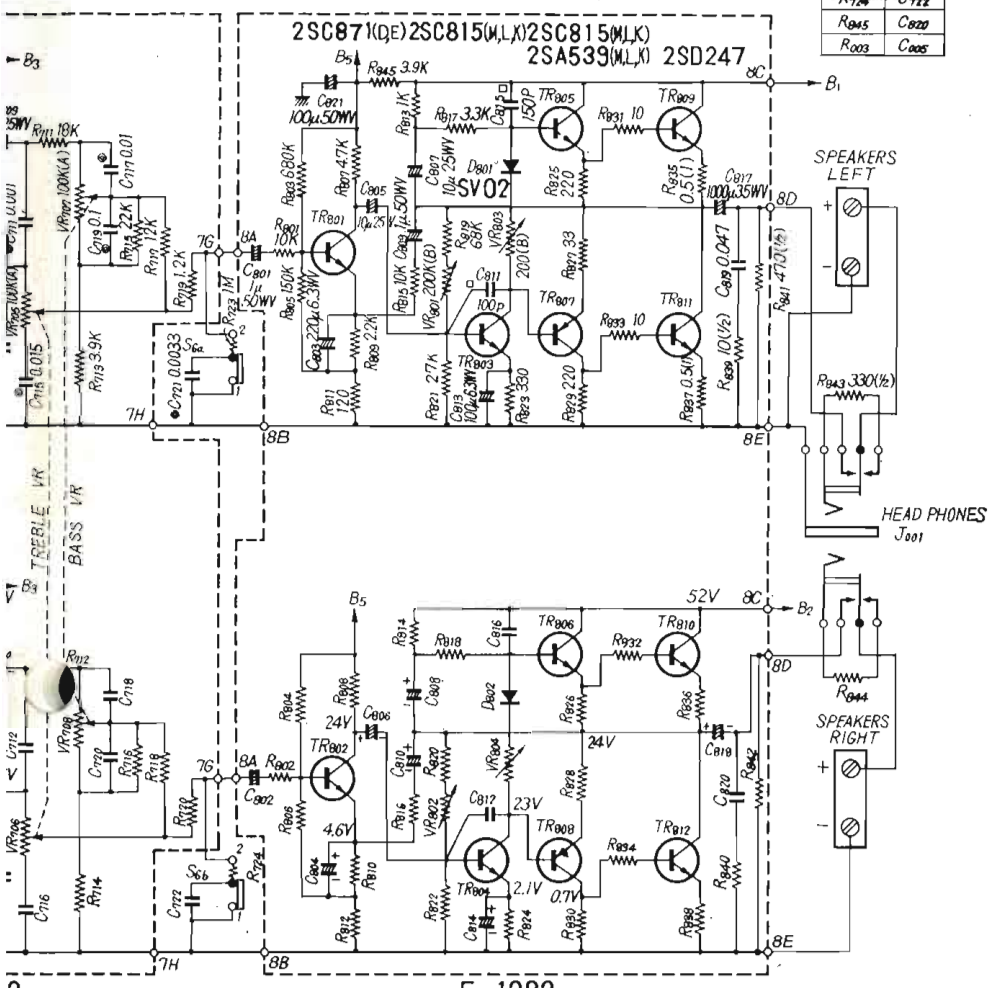

F-1082

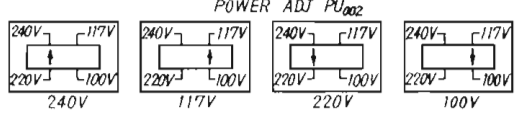
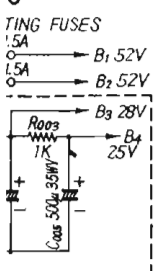

- SYMBOL**
- OIL
 - MICA
 - MYLAR
 - △ CERAMIC
 - ◆ TANTALUM
- S1(a-d) SELECTOR SW**
- 1 TAPE HD
 - 2 PHONO 1
 - 3 PHONO 2
 - 4 AUX 1
 - 5 AUX 2
- S3 MODE SW**
- 1 STEREO
 - 2 MONO
- S4(a,b) LOUDNESS SW**
- 1 OFF
 - 2 ON
- S5(a,b) LOW FILTER SW**
- 1 OFF
 - 2 ON
- S6(a,b) HIGH FILTER SW**
- 1 OFF
 - 2 ON
- S7 POWER SW**
- 1 OFF
 - 2 ON
- S3(a,b) TAPE MONITOR**
- 1 SOURCE
 - 2 PLAYBACK
- VR001, VR002 --- AC BALANCE**
- VR003, VR004 --- DC BALANCE**

ALL RESISTOR 1/4 WATT UNLESS OTHERWISE NOTED

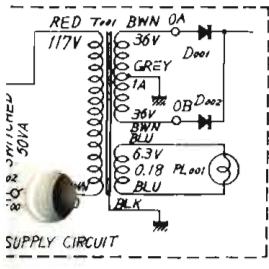

GENERAL TROUBLESHOOTING CHART

In some instances, the amplifier which is operating satisfactorily develops hum or noise as listed on this page. In this case, eliminate the trouble source as indicated in the column under **WHAT TO DO**.

If you are confronted with a trouble not covered here or if you have any questions concerning the operation and maintenance of this amplifier, please contact our Customer Service Department.

If the amplifier is operating satisfactorily, the trouble may be attributed to the following:

1. Incorrect connections to or loose terminal contact with the speakers, record player, tape recorder or deck, line cord etc.
2. Incorrect operation of the amplifier and/or other components.
3. Improper positioning of the components such as speakers and record player.
4. Defective component or components connected to the amplifier.

The next step to do is listed below:

PROGRAM SOURCE	SYMPTOM	PROBABLE CAUSE	WHAT TO DO
Tuner	Noise is heard continuously or intermittently at a particular time of a day or in a certain area.	<ul style="list-style-type: none"> * Discharge or oscillation caused by electrical appliances, such as fluorescent lamp, TV set, D. C. motor, rectifier, oscillator etc. * Insufficient antenna input or reception in fringe area * Wave interference * Natural phenomena, such as atmospherics, statics, strays and thunderbolt 	<ul style="list-style-type: none"> * Attach a noise limiter to the electrical appliance that causes the noise, or attach it to the tuner. * Keep the said electrical appliance well away from the tuner. * Install an outdoor antenna and ground the amp to raise the signal-to-noise ratio. * If the noise occurs at a certain frequency, attach a wave trap to the ANT input. * Reverse the power cord plug-receptacle connections.
	During AM reception, noise is heard at a particular time of a day, in a certain area or over part of dial.	<ul style="list-style-type: none"> * Field intensity of AM signals 	<ul style="list-style-type: none"> * Reset AM antenna for better reception * Ground the amp, or reverse the power cord plug-receptacle connections.
	High-frequency noise is heard during AM reception.	<ul style="list-style-type: none"> * Beat interference, i. e., interaction of two stations closely spaced * TV set close to the audio system 	<ul style="list-style-type: none"> * The noise caused by beat interference cannot be completely eliminated. But it is advisable to turn the TREBLE control to the minimum counterclockwise position and turn the HIGH filter * Keep the TV set well away from the audio system.

PROGRAM SOURCE	SYMPTOM	PROBABLE CAUSE	WHAT TO DO
	Noise during FM reception	* Poor noise limiter effect or too low S/N ratio due to insufficient antenna input	* Install the antenna for maximum signal strength. * If this does not prove effective, use an outdoor antenna designed exclusively for FM. * When you make use of an existing TV antenna for this purpose, attach a divider to prevent interaction. * Note that excessively long antenna may rather cause a noise.
	Note: FM reception is affected considerably by the conditions of transmission by stations: power and antenna efficiency. As a result, you may receive one station quite well while having difficulty in receiving another station.		
	Noise is heard suddenly during FM reception.	* Ignition noise caused by starting of an automobile engine	* Keep the antenna and its lead-in wire well away from the road side. Or raise the antenna input as described above.
	Noise is heard during FM stereo reception while being not heard during FM mono.	* The service area of FM stereo broadcast is only half as much as that of the FM mono.	* Install the antenna for maximum antenna input. * Turn on the HIGH filter and/or turn the TREBLE control to the minimum counterclockwise position.
Record player, tape recorder or deck	Hum or howling	* Record player placed directly on the speaker box * Connecting wire not shielded * Loose terminal contact * Connecting cord too close to the power cord, fluorescent lamp or other electrical appliances * Nearby amateur radio station or TV transmission antenna	* Put a cushion between record player and speaker box or keep them away from each other. * Use shielded cord. * Switch on the LOW filter and/or turn the BASS control from midpoint to left. * Make connecting cord as short as possible. * Connect cord tightly at terminals. * Keep connecting cord well away from them. * Consult the nearest Radio Regulatory Bureau.
	Surface noise	* Worn or old record * Worn or dusty pickup needle. * Improper needle pressure	* Turn the TREBLE control properly from mid-point to left and/or switch on the HIGH filter. Adjust the needle pressure.
Common to all program sources	The BALANCE control is not at the midpoint when equal sound comes from left and right channel.	* The BALANCE control is not always set to the midpoint depending the source materials.	* Proper balance exists when the sound seem to originate at a point midway between the speakers.

PARTS LAYOUT



DISASSEMBLY PROCEDURE

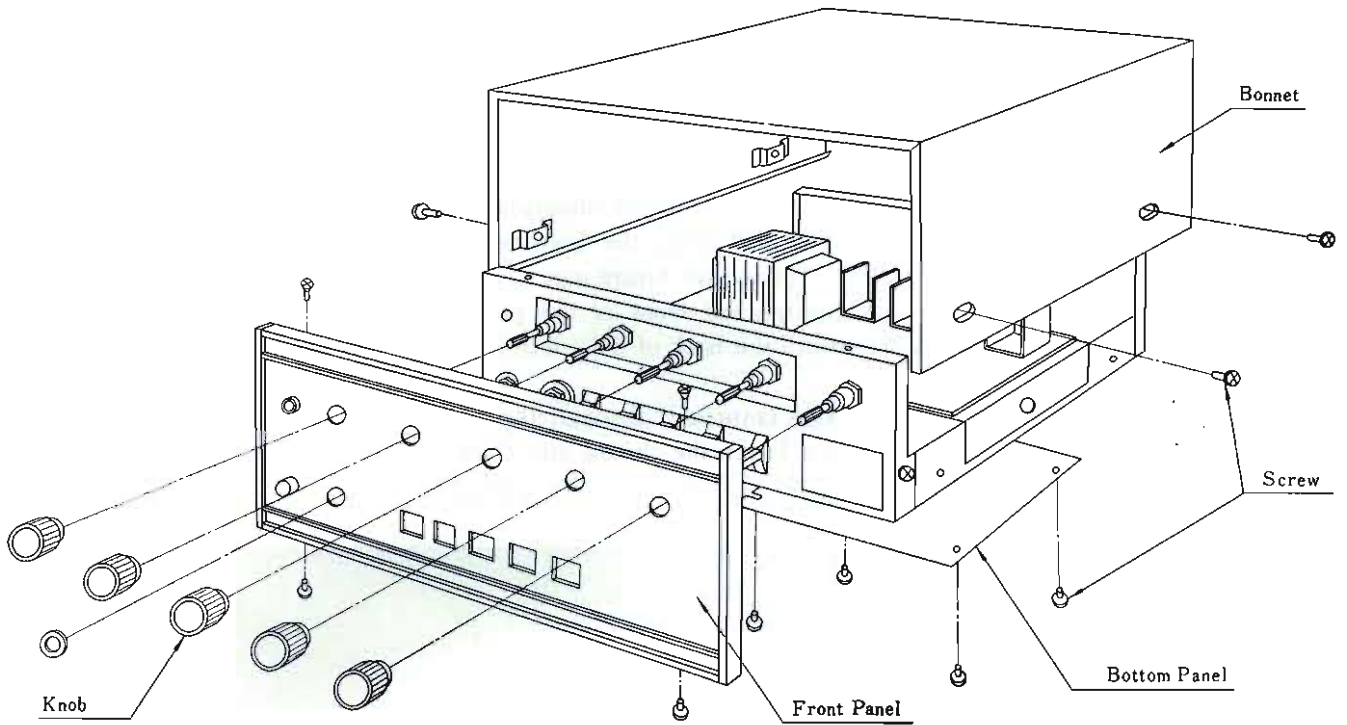

CUSTOM MOUNTING

For the custom built installation, proceed as follows :

1. Saw a cutout through the front panel of your cabinet to the dimensions given in the illustration below.
2. Obtain a strip of wood $\frac{3}{4}$ -inch square and 16 inch long. Cut this strip in half to form to 8-inch cleats. Fasten them to the top of the mounting board as indicated on opposite page.
3. Drill two $\frac{2}{5}$ -inch holes through the mounting board and cleats as indicated.
4. Remove the bonnet from the chassis as illustrated below.
5. Remove four mounting feet from the bottom of the chassis. The mounting feet should be retained for future use.
6. Insert the chassis through the front of the panel cutout. Slide the chassis into the cabinet until the back of the control panel is tight against the panel of the cabinet.
7. Insert the butterfly bolts (supplied) through the holes in the bottom of the mounting board and fasten the chassis into place:

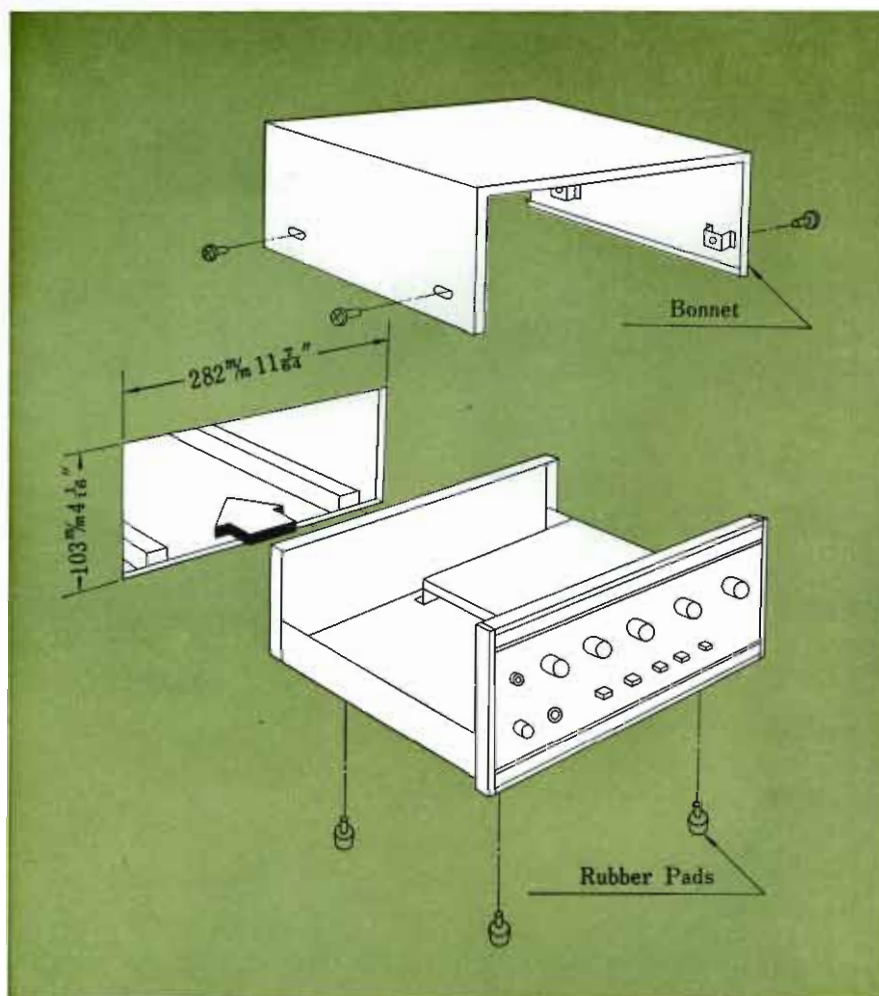

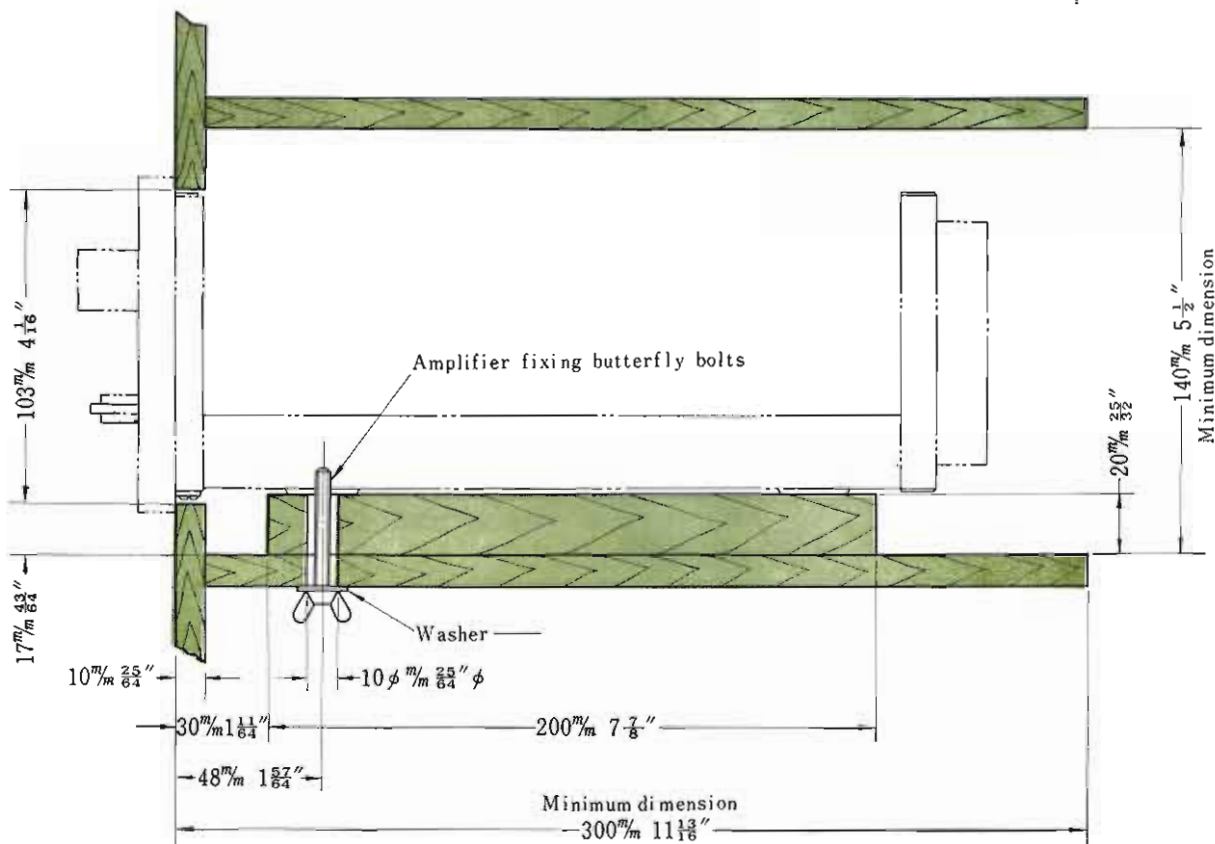
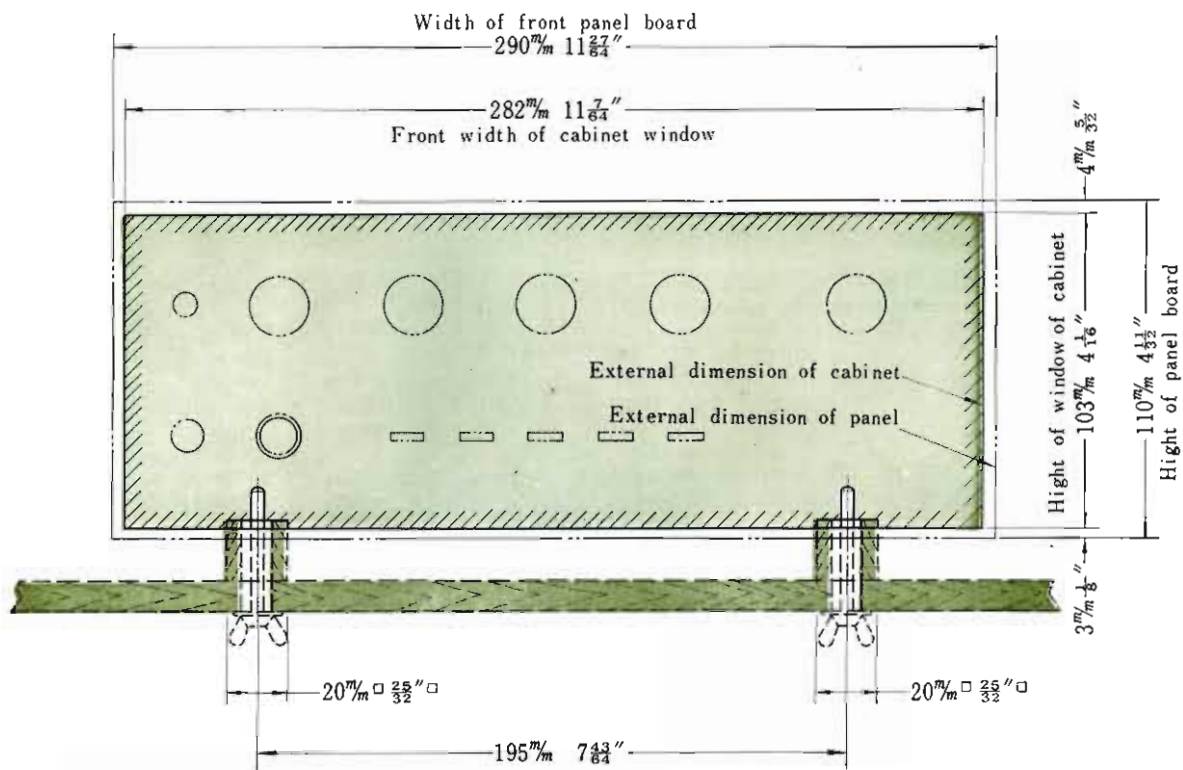

MAIN AMP. ALIGNMENT

OUTPUT ADJUSTMENT

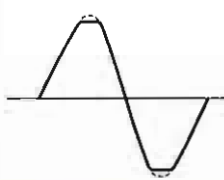
STEP	PROCEDURE	NOTE
1.	Adjust the volume control to minimum.	
2.	Set an oscillator to 1,000 Hz and connect it to the LEFT AUX 2 input.	The oscillator used should have the oscillation frequency of 20 to 20,000 Hz and the output voltage of more than 200 mV.
3.	Set the SELECTOR switch to AUX. 2.	Set other controls and switches as follows: BALANCE to 0 TAPE MON. to SOURCE MODE to STEREO TONE to 0 Others to OFF
4.	Connect a 8- or 16-ohm load resistor having capacity of more than 30 watts to the LEFT SPEAKER output.	
5.	Connect an oscilloscope to the SPEAKER terminal.	
6.	Push the POWER switch on and increase the volume little by little. Check the output at the terminal by means of the oscilloscope.	
7.	Adjust VR ₈₀₁ so that the fronts of sine wave clipped simultaneously, are	
8.	Adjust the right channel as above. In Step 7, adjust VR ₈₀₂ .	

CURRENT ADJUSTMENT

STEP	SETTING OF AMMETER (TESTER)	WHAT TO DO	NOTE
1.		Remove F ₀₀₁ and F ₀₀₂ .	Use an ammeter having 100 or 50 mA range.
2.		Set VR ₈₀₃ and VR ₈₀₄ to minimum.	
3.		Push the POWER switch ON	
4.	100 mA range.	Connect the ammeter in place of F ₀₀₁ . The ⊕ terminal of the ammeter should be connected to the OC side in the Circuit Diagram and the ⊖ terminal to the 8C side.	Be sure to switch on 1st and then connect the ammeter
5.		Turn VR ₈₀₃ clockwise and adjust current to 16 to 20 mA at room temperature of 25°C or less or to 20 to 24 mA at 25°C or more	
6.		Push the POWER switch OFF and attach F ₀₀₁ in place.	
7.	100 mA range.	Push the POWER switch ON and connect the ammeter in place of F ₀₀₂ . The ⊕ terminal of the ammeter should be connected to the OC side in the Circuit Diagram and the ⊖ terminal to the 8C side.	
8.		Turn VR ₈₀₄ clockwise and adjust current to 16 to 20 mA at room temperature of 25°C or less or to 20 to 24 mA at 25°C or more.	

TEST POINT

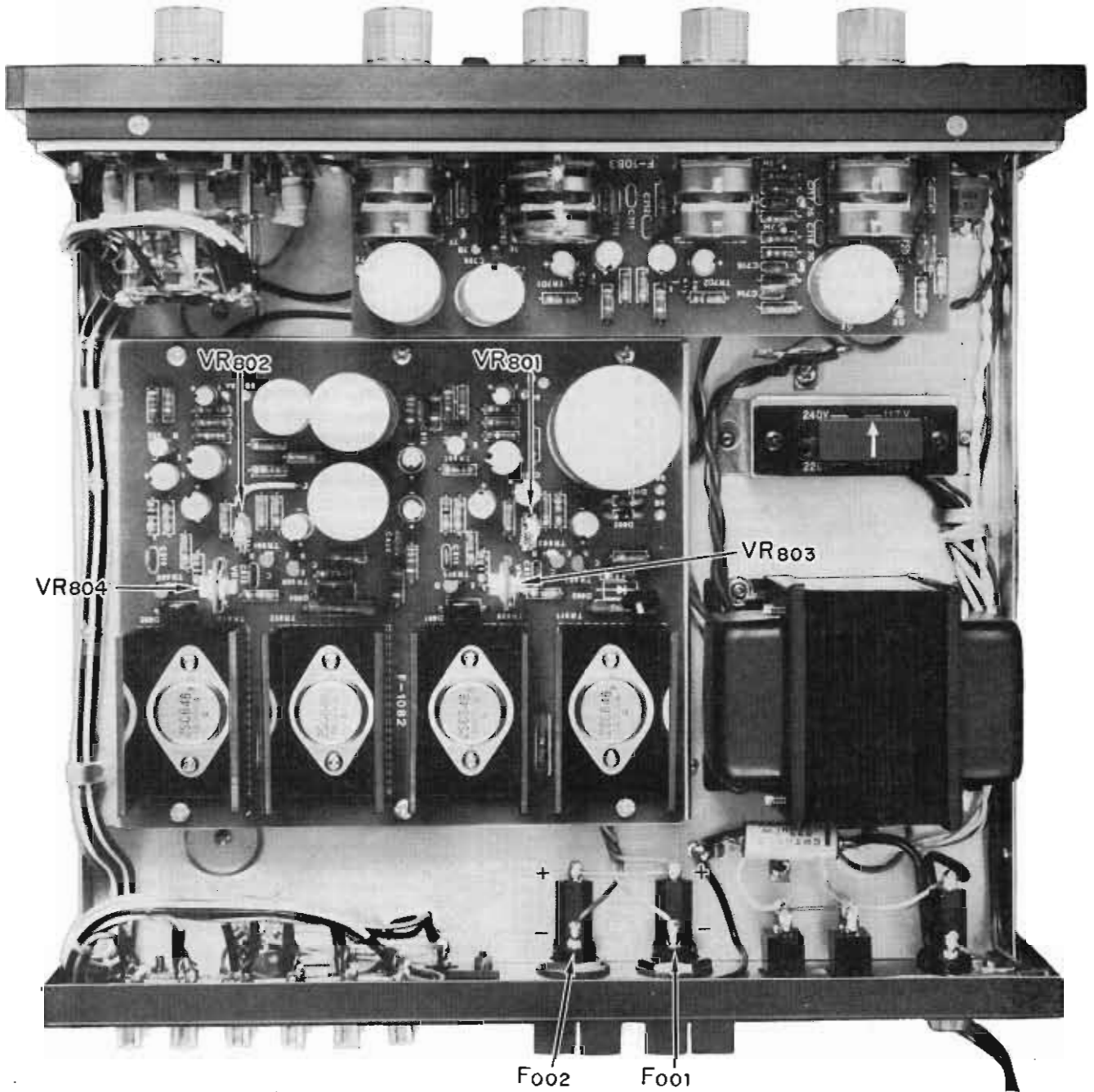

PRINTED CIRCUIT SHEETS AND PARTS LIST

HEAD AMP <F-1064>

X	Y	Z
R601	2.2kΩ ±10% ¼W Carbon Resistor	2 A
R602	2.2kΩ ±10% ¼W Carbon Resistor	1 A
R603	680kΩ ±10% ¼W Carbon Resistor	2 A
R604	680kΩ ±10% ¼W Carbon Resistor	1 A
R605	220kΩ ±10% ¼W Carbon Resistor	2 A
R606	220kΩ ±10% ¼W Carbon Resistor	1 A
R607	2.2kΩ ±10% ¼W Carbon Resistor	2 A
R608	2.2kΩ ±10% ¼W Carbon Resistor	1 A
R609	470kΩ ±10% ¼W Carbon Resistor	2 A
R610	470kΩ ±10% ¼W Carbon Resistor	1 A
R611	8.2kΩ ±10% ¼W Carbon Resistor	2 B
R612	8.2kΩ ±10% ¼W Carbon Resistor	1 B
R613	220Ω ±10% ¼W Carbon Resistor	2 A
R614	220Ω ±10% ¼W Carbon Resistor	1 A
R615	560Ω ±10% ¼W Carbon Resistor	2 B
R616	560Ω ±10% ¼W Carbon Resistor	1 B
R617	82kΩ ±10% ¼W Carbon Resistor	2 B
R618	82kΩ ±10% ¼W Carbon Resistor	1 B
R619	100Ω ±10% ¼W Carbon Resistor	2 C
R620	100Ω ±10% ¼W Carbon Resistor	1 B
R621	470Ω ±10% ¼W Carbon Resistor	2 B
R622	470Ω ±10% ¼W Carbon Resistor	1 B
R623	4.7MΩ ±10% ¼W Carbon Resistor	2 B
R624	4.7MΩ ±10% ¼W Carbon Resistor	1 C
R625	12kΩ ±10% ¼W Carbon Resistor	2 B
R626	12kΩ ±10% ¼W Carbon Resistor	1 C
R627	470kΩ ±10% ¼W Carbon Resistor	2 C
R628	470kΩ ±10% ¼W Carbon Resistor	1 C
R629	22kΩ ±10% ¼W Carbon Resistor	2 C

X: Parts No Y: Parts Name Z: Position of Parts
(Co-ordinate number and letter in printed circuit)

X	Y	Z
R630	22kΩ ±10% ¼W Carbon Resistor	1 C
R631	3.9kΩ ±10% ¼W Carbon Resistor	2 C
R632	3.9kΩ ±10% ¼W Carbon Resistor	1 B
C601	1.5μF 15 WV Tantalum Electrolytic Capacitor	2 A
C602	1.5μF 15 WV Tantalum Electrolytic Capacitor	1 A
C603	150 pF ±10% 50 WV Mica Capacitor	2 A
C604	150 pF ±10% 50 WV Mica Capacitor	1 A
C605	220μF 6.3 WV Electrolytic Capacitor	2 A
C606	220μF 6.3 WV Electrolytic Capacitor	1 A
C607	47 pF ±10% 50 WV Mica Capacitor	2 A
C608	47 pF ±10% 50 WV Mica Capacitor	1 A
C609	10μF 25 WV Electrolytic Capacitor	2 B
C610	10μF 25 WV Electrolytic Capacitor	1 B
C611	47μF 6.3 WV Electrolytic Capacitor	2 A
C612	47μF 6.3 WV Electrolytic Capacitor	1 A
C613	0.004μF ±10% 50 WV Mylar Capacitor	2 B
C614	0.004μF ±10% 50 WV Mylar Capacitor	1 C
C615	0.01μF ±10% 50 WV Mylar Capacitor	2 C
C616	0.01μF ±10% 50 WV Mylar Capacitor	1 B
C617	0.0033μF ±10% 50 WV Mylar Capacitor	2 C
C618	0.0033μF ±10% 50 WV Mylar Capacitor	1 C
TR601	2SC871F 030547-2	2 A
TR602	2SC871F 030547-2	1 A
TR603	2SC733(Y, GR) 030537-1	2 A
TR604	2SC733(Y, GR) 030537-2	1 A

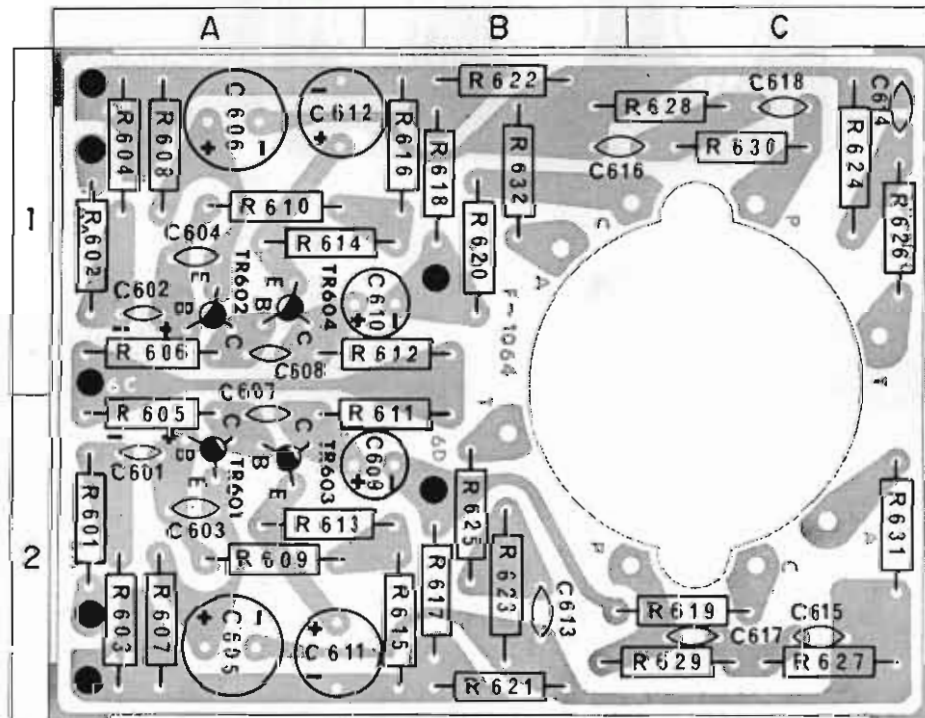

CONTROL AMP <F-1083>

X	Y	Z
R701	33 kΩ ±10% ¼W Carbon Resistor	2D
R702	33 kΩ ±10% ¼W Carbon Resistor	2D
R703	1 kΩ ±10% ¼W Carbon Resistor	2C
R704	1 kΩ ±10% ¼W Carbon Resistor	2B
R705	1MΩ ±10% ¼W Carbon Resistor	1C
R706	1MΩ ±10% ¼W Carbon Resistor	1B
R707	15 kΩ ±10% ¼W Carbon Resistor	1C
R708	15 kΩ ±10% ¼W Carbon Resistor	1C
R709	680Ω ±10% ¼W Carbon Resistor	1C
R710	680Ω ±10% ¼W Carbon Resistor	1B
R711	18 kΩ ±10% ¼W Carbon Resistor	2B
R712	18 kΩ ±10% ¼W Carbon Resistor	1B
R713	3.9 kΩ ±10% ¼W Carbon Resistor	1A
R714	3.9 kΩ ±10% ¼W Carbon Resistor	1A
R715	22 kΩ ±10% ¼W Carbon Resistor	2A
R716	22 kΩ ±10% ¼W Carbon Resistor	1A
R717	12 kΩ ±10% ¼W Carbon Resistor	2B
R718	12 kΩ ±10% ¼W Carbon Resistor	2B
R719	1.2 kΩ ±10% ¼W Carbon Resistor	2B
R720	1.2 kΩ ±10% ¼W Carbon Resistor	1B
R001	3.3 kΩ ±10% ¼W Carbon Resistor	1A
R002	1 kΩ ±10% ¼W Carbon Resistor	1B
R003	1 kΩ ±10% ¼W Carbon Resistor	1C
C701	180 pF ±10% 50 WV Mica Capacitor	2D
C702	180 pF ±10% 50 WV Mica Capacitor	2D
C705	0.022 μF ±10% 50 WV Mylar Capacitor	2D
C706	0.022 μF ±10% 50 WV Mylar Capacitor	2D
C707	3.3 μF 25 WV Electrolytic Capacitor	1C
C708	3.3 μF 25 WV Electrolytic Capacitor	1B
C709	10 μF 25 WV Electrolytic Capacitor	1C
C710	10 μF 25 WV Electrolytic Capacitor	1B
C711	0.001 μF ±10% 50 WV Mylar Capacitor	2C
C712	0.001 μF ±10% 50 WV Mylar Capacitor	2C
C713	100 pF ±10% 50 WV Mica Capacitor	2C
C714	100 pF ±10% 50 WV Mica Capacitor	1B
C715	0.015 μF ±10% 50 WV Mylar Capacitor	2B
C716	0.015 μF ±10% 50 WV Mylar Capacitor	1B
C717	0.01 μF ±10% 50 WV Mylar Capacitor	2A
C718	0.01 μF ±10% 50 WV Mylar Capacitor	2A
C719	0.1 μF ±10% 50 WV Mylar Capacitor	2A
C720	0.1 μF ±10% 50 WV Mylar Capacitor	1A
C003	500 μF 35 WV Electrolytic Capacitor 020529	1A
C004	220 μF 50 WV Electrolytic Capacitor 020529	1D
C005	500 μF 35 WV Electrolytic Capacitor 020529	1D
TR701	25C871(D) 030547	1C
TR702	25C871(D) 030547	1B
VR701	125 kΩ(M, N) 101022	2D
VR702		
VR703	250 kΩ(B) 101020	2C
VR704		
VR705	100 kΩ(A) 101023	2B
VR706		
VR707	100 kΩ(A) 101023	2A
VR708		

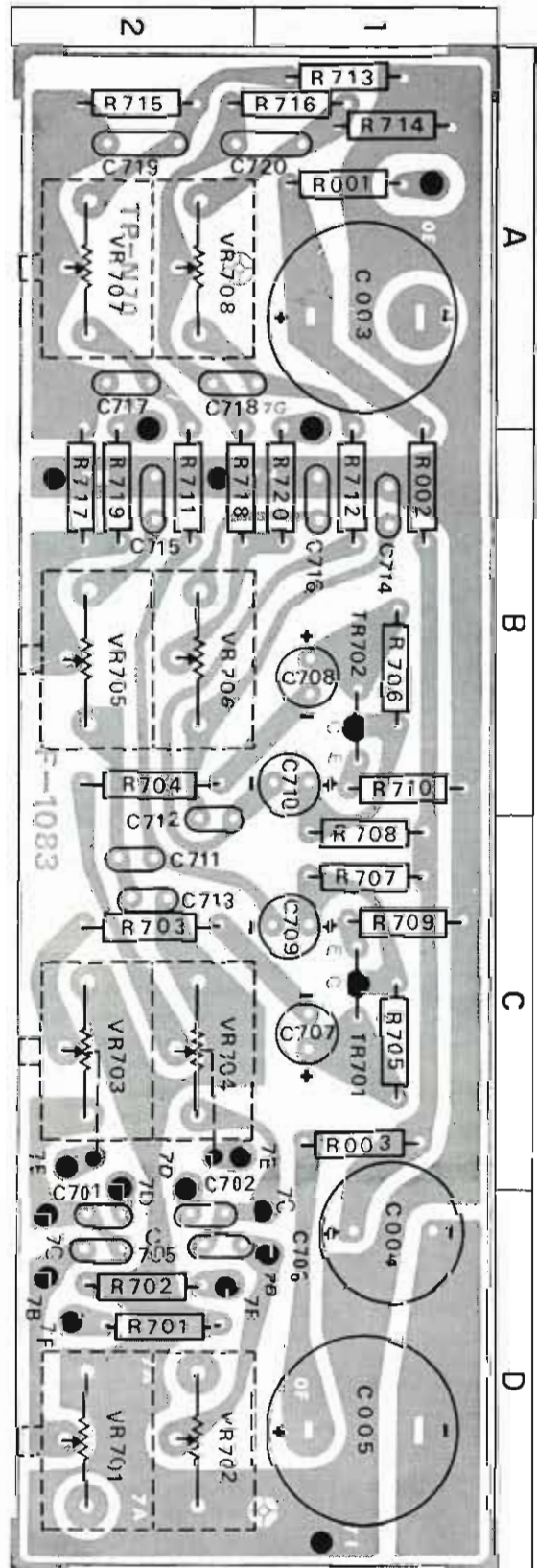

PRINTED CIRCUIT SHEETS AND PARTS LIST

MAIN AMP (F-1082)

X	Y	Y
R801	10 k Ω \pm 10% $\frac{1}{4}$ W Carbon Resistor	3 B
R802	10 k Ω \pm 10% $\frac{1}{4}$ W Carbon Resistor	3 D
R803	680 k Ω \pm 10% $\frac{1}{4}$ W Carbon Resistor	3 B
R804	680 k Ω \pm 10% $\frac{1}{4}$ W Carbon Resistor	3 D
R805	150 k Ω \pm 10% $\frac{1}{4}$ W Carbon Resistor	3 B
R806	150 k Ω \pm 10% $\frac{1}{4}$ W Carbon Resistor	3 D
R807	4.7 k Ω \pm 10% $\frac{1}{4}$ W Carbon Resistor	3 B
R808	4.7 k Ω \pm 10% $\frac{1}{4}$ W Carbon Resistor	3 D
R809	2.2 k Ω \pm 10% $\frac{1}{4}$ W Carbon Resistor	3 B
R810	2.2 k Ω \pm 10% $\frac{1}{4}$ W Carbon Resistor	3 D
R811	120 Ω \pm 10% $\frac{1}{4}$ W Carbon Resistor	3 B
R812	120 Ω \pm 10% $\frac{1}{4}$ W Carbon Resistor	3 C
R813	1 k Ω \pm 10% $\frac{1}{4}$ W Carbon Resistor	2 B
R814	1 k Ω \pm 10% $\frac{1}{4}$ W Carbon Resistor	2 D
R815	10 k Ω \pm 10% $\frac{1}{4}$ W Carbon Resistor	3 B
R816	10 k Ω \pm 10% $\frac{1}{4}$ W Carbon Resistor	3 C
R817	3.3 k Ω \pm 10% $\frac{1}{4}$ W Carbon Resistor	2 B
R818	3.3 k Ω \pm 10% $\frac{1}{4}$ W Carbon Resistor	2 D
R819	68 k Ω \pm 10% $\frac{1}{4}$ W Carbon Resistor	2 B
R820	68 k Ω \pm 10% $\frac{1}{4}$ W Carbon Resistor	2 D
R821	27 k Ω \pm 10% $\frac{1}{4}$ W Carbon Resistor	2 A
R822	27 k Ω \pm 10% $\frac{1}{4}$ W Carbon Resistor	2 C
R823	330 Ω \pm 10% $\frac{1}{4}$ W Carbon Resistor	2 A
R824	330 Ω \pm 10% $\frac{1}{4}$ W Carbon Resistor	2 C
R825	220 Ω \pm 10% $\frac{1}{4}$ W Carbon Resistor	2 B
R826	220 Ω \pm 10% $\frac{1}{4}$ W Carbon Resistor	2 D
R827	33 Ω \pm 10% $\frac{1}{4}$ W Carbon Resistor	2 A, B
R828	33 Ω \pm 10% $\frac{1}{4}$ W Carbon Resistor	2 C, B
R829	220 Ω \pm 10% $\frac{1}{4}$ W Carbon Resistor	2 A
R830	220 Ω \pm 10% $\frac{1}{4}$ W Carbon Resistor	2 C
R831	10 Ω \pm 10% $\frac{1}{4}$ W Carbon Resistor	2 B
R832	10 Ω \pm 10% $\frac{1}{4}$ W Carbon Resistor	2 D
R833	10 Ω \pm 10% $\frac{1}{4}$ W Carbon Resistor	2 A
R834	10 Ω \pm 10% $\frac{1}{4}$ W Carbon Resistor	2 C
R835	0.5 Ω \pm 10% 1W Wound Resistor 012026	1 B
R836	0.5 Ω \pm 10% 1W Wound Resistor 012026	1 C
R837	0.5 Ω \pm 10% 1W Wound Resistor 012026	2 A
R838	0.5 Ω \pm 10% 1W Wound Resistor 012026	2 C
R839	10 Ω \pm 10% $\frac{1}{2}$ W Solid Resistor	3 B
R840	10 Ω \pm 10% $\frac{1}{2}$ W Solid Resistor	2 C
R841	470 Ω \pm 10% $\frac{1}{2}$ W Solid Resistor	3 B
R842	470 Ω \pm 10% $\frac{1}{2}$ W Solid Resistor	2 C
R845	3.9 k Ω \pm 10% $\frac{1}{4}$ W Carbon Resistor	1 C
C801	1 μ F 50 WV Electrolytic Capacitor	3 B
C802	1 μ F 50 WV Electrolytic Capacitor	3 D
C803	220 μ F 6.3 WV Electrolytic Capacitor	3 B
C804	220 μ F 6.3 WV Electrolytic Capacitor	3 D
C805	10 μ F 25 WV Electrolytic Capacitor	3 B
C806	10 μ F 25 WV Electrolytic Capacitor	3 D
C807	10 μ F 25 WV Electrolytic Capacitor	2, 3 B
C808	10 μ F 25 WV Electrolytic Capacitor	2, 3 B
C809	1 μ F 50 WV Electrolytic Capacitor	3 B
C810	1 μ F 50 WV Electrolytic Capacitor	2 B
C811	100 pF \pm 10% 50 WV Mica Capacitor	2 B
C812	100 pF \pm 10% 50 WV Mica Capacitor	2 D
C813	100 μ F 6.3 WV Electrolytic Capacitor	2 A

X: Parts No Y: Parts Name Z: Position of Parts
(Co-ordinate number and letter in printed circuit)

X	Y	Z
C814	100 μ F 6.3 WV Electrolytic Capacitor	2 C
C815	150 pF \pm 10% 50 WV Mica Capacitor	2 B
C816	150 pF \pm 10% 50 WV Mica Capacitor	2 D
C817	1000 μ F 35 WV Electrolytic Capacitor 020534	2, 3 C
C818	1000 μ F 35 WV Electrolytic Capacitor 020534	3 C
C819	0.047 μ F \pm 10% 50 WV Mylar Capacitor	3 B
C820	0.047 μ F \pm 10% 50 WV Mylar Capacitor	2 C
C821	100 μ F 50 WV Electrolytic Capacitor	3 C
C822	1500 μ F 63 WV Electrolytic Capacitor 020537	3 A
D801	SV02 031049	2 B
D802	SV02 031049	2 D
TR801	2SC871 D,F 030547-1	3 B
TR802	2SC871 D,F 030547-1 (M) 030543	3 D
TR803	2SC815(L) 030543-1 (K) 030543-2	2 A
TR804	2SC815(L) 030543 (K) 030543-1 (M) 030543-2	2 C
TR805	2SC815(L) 030543 (K) 030543-1 (M) 030543-2	2 B
TR806	2SC815(L) 030543 (K) 030543-1 (M) 030011	2 D
TR807	2SA539(L) 030011-1 (K) 030011-2	2 A
TR808	2SA539(L) 030011 (K) 030011-1 030011-2	2 C
TR809	2SD247 or 2SC1030(B, C) 030819-1	1 B
TR810	2SD247 or 2SC1030(B, C) 030819-1	1 D
TR811	2SD247 or 2SC1030(B, C) 030819-1	1 A
TR812	2SD247 or 2SC1030(B, C) 030819-1	1 C
D001	10D-1 031034	2 A
D002	10D-1 031034	2 A
VR801	200 k Ω (B) 103045	2 B
VR802	200 k Ω (B) 103045	2 D
VR803	200 Ω (B) 103012	2 B
VR804	200 Ω (B) 103012	2 D

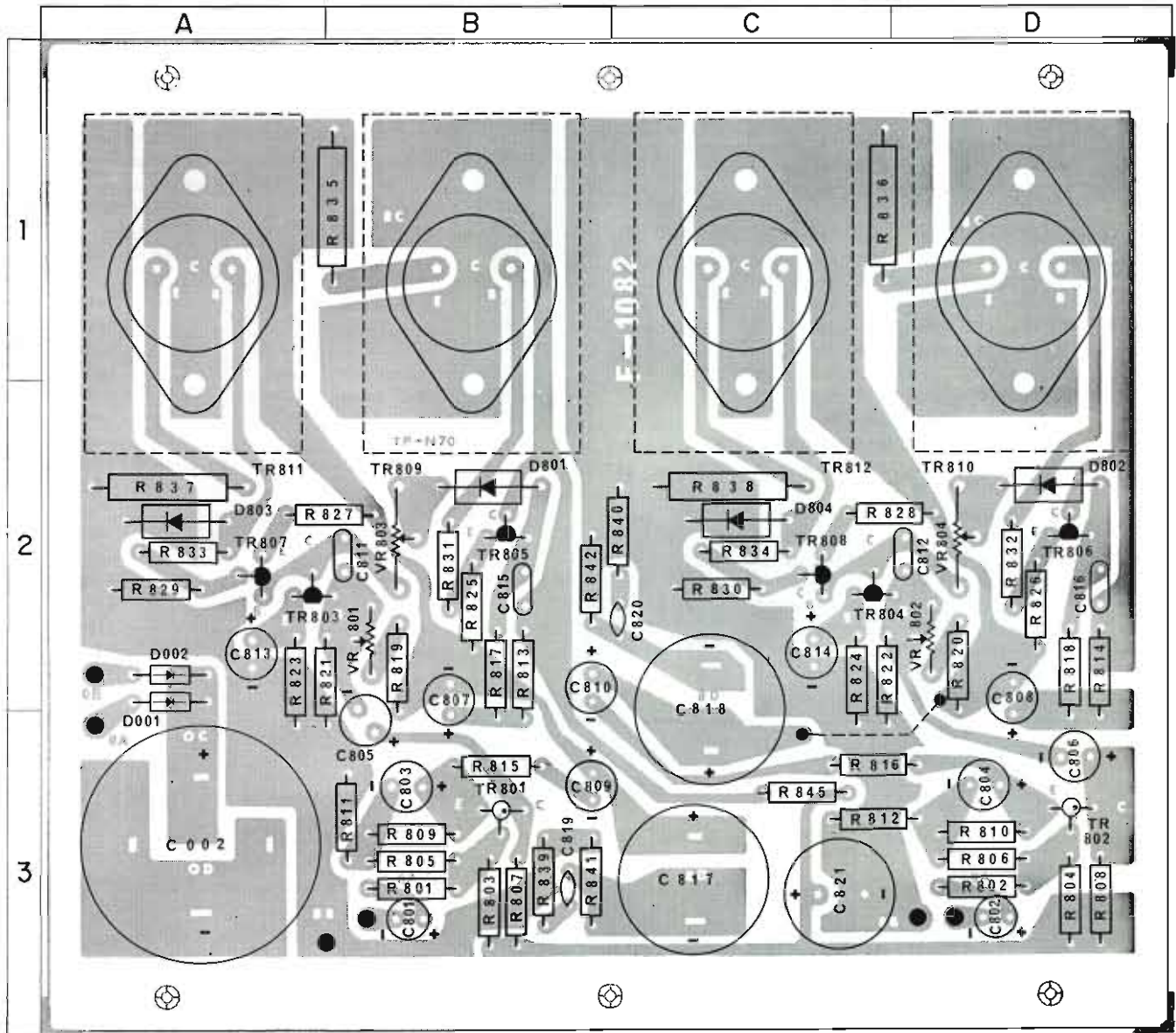

OTHER PARTS AND THEIR POSITION ON CHASSIS

X	Y
R633	12 k Ω \pm 10% $\frac{1}{4}$ W Carbon Resistor
R634	12 k Ω \pm 10% $\frac{1}{4}$ W Carbon Resistor
R635	68 k Ω \pm 10% $\frac{1}{4}$ W Carbon Resistor
R636	68 k Ω \pm 10% $\frac{1}{4}$ W Carbon Resistor
R637	180 k Ω \pm 10% $\frac{1}{4}$ W Carbon Resistor
R638	180 k Ω \pm 10% $\frac{1}{4}$ W Carbon Resistor
R639	100 k Ω \pm 10% $\frac{1}{4}$ W Carbon Resistor
R640	100 k Ω \pm 10% $\frac{1}{4}$ W Carbon Resistor
R641	15 k Ω \pm 10% $\frac{1}{4}$ W Carbon Resistor
R642	15 k Ω \pm 10% $\frac{1}{4}$ W Carbon Resistor
R643	100 k Ω \pm 10% $\frac{1}{4}$ W Carbon Resistor
R644	100 k Ω \pm 10% $\frac{1}{4}$ W Carbon Resistor
R645	15 k Ω \pm 10% $\frac{1}{4}$ W Carbon Resistor
R646	15 k Ω \pm 10% $\frac{1}{4}$ W Carbon Resistor
R647	470 k Ω \pm 10% $\frac{1}{4}$ W Carbon Resistor
R648	470 k Ω \pm 10% $\frac{1}{4}$ W Carbon Resistor
R649	100 k Ω \pm 10% $\frac{1}{4}$ W Carbon Resistor
R650	100 k Ω \pm 10% $\frac{1}{4}$ W Carbon Resistor
R651	470 k Ω \pm 10% $\frac{1}{4}$ W Carbon Resistor
R652	470 k Ω \pm 10% $\frac{1}{4}$ W Carbon Resistor
R721	1M Ω \pm 10% $\frac{1}{4}$ W Carbon Resistor
R722	1M Ω \pm 10% $\frac{1}{4}$ W Carbon Resistor
R723	1M Ω \pm 10% $\frac{1}{4}$ W Carbon Resistor
R724	1M Ω \pm 10% $\frac{1}{4}$ W Carbon Resistor
R843	330 Ω \pm 10% $\frac{1}{2}$ W Solid Resistor
R844	330 Ω \pm 10% $\frac{1}{2}$ W Solid Resistor

X: Parts No
Y: Parts Name

X	Y
C619	0.05 μ F \pm 10% 50WV Ceramic Capacitor
C620	0.05 μ F \pm 10% 50WV Ceramic Capacitor
C703	0.022 μ F \pm 10% 50WV Mylar Capacitor
C704	0.022 μ F \pm 10% 50WV Mylar Capacitor
C721	0.0033 μ F \pm 10% 50WV Mylar Capacitor
C722	0.0033 μ F \pm 10% 50WV Mylar Capacitor
C001	0.033 μ F \pm 10% 600WV Oil Capacitor
J001	Head phone Jack 243006
PU001	5-pin Connector 243004
PU001	Voltage Selector Socket 241008
PU002	Voltage Selector Plug 241009
F001	Quick Acting Fuse AGB 1.5A 043010
F002	Quick Acting Fuse AGB 1.5A 043010
F003	Power Fuse 2A 043003
PL001	Power Indicator Lamp 8V 0.15A 040005
CO001	AC Outlet 245001-1
CO002	AC Outlet 245001-1
T001	Power Transformer 400-5317 400029
S1(a-d)	Selector Switch 110315
S2(a, b)	Tape Monitor Switch 117006
S3	Mode Switch 117006
S4(a, b)	Loudness Switch 117006
S5(a, b)	Low Filter Switch 117006
S6(a, b)	High Filter Switch 117006
S7	Power Switch 112009

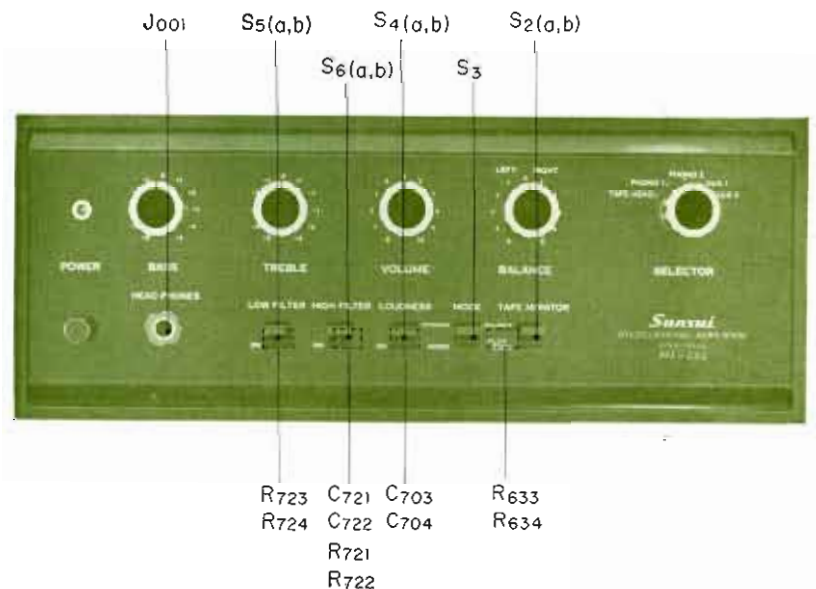

* Design and specifications subject to change without notice for improvements.

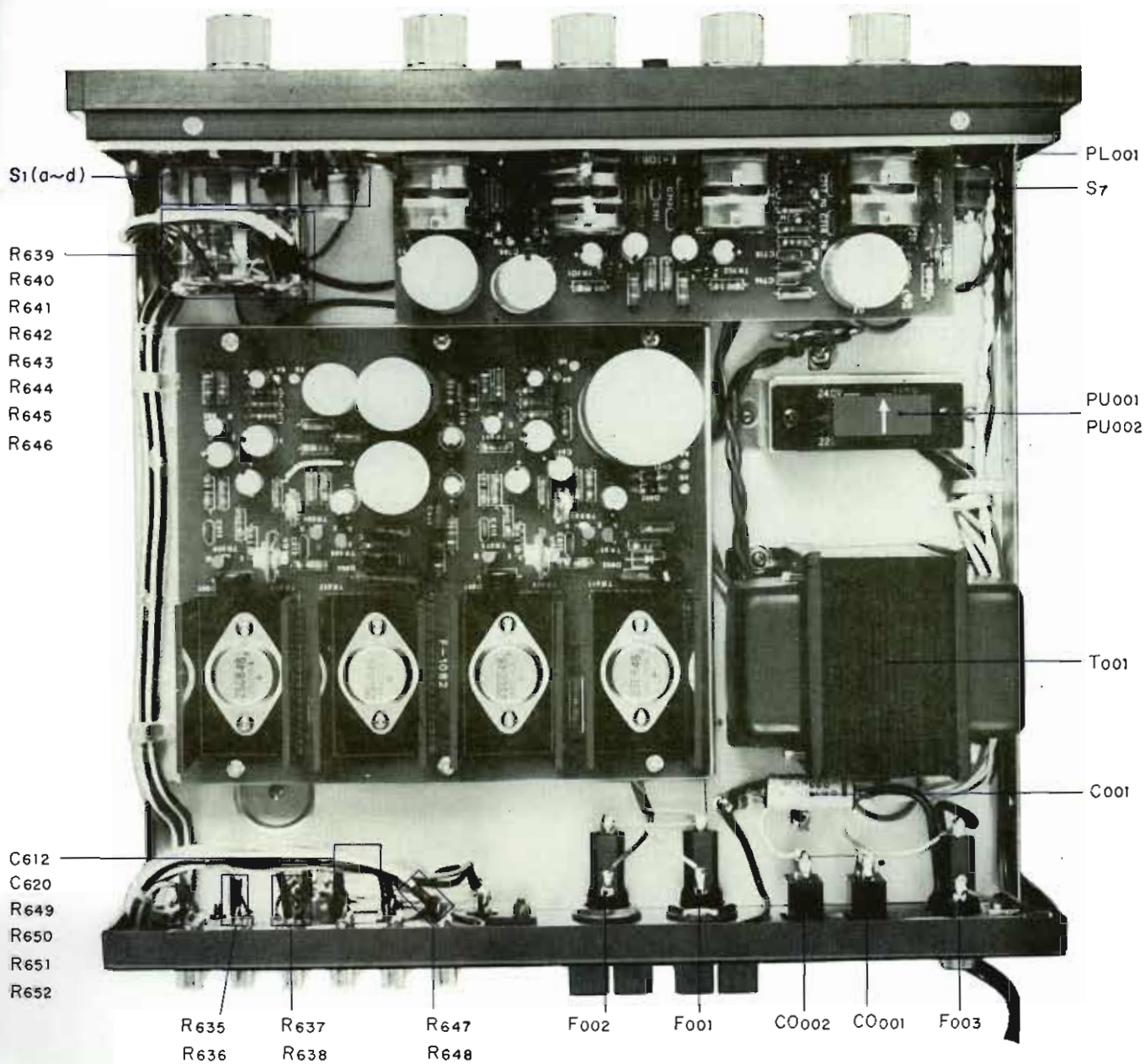



SANSUI ELECTRIC CO., LTD.

14-1, 2-chome, Izumi, Suginamiku, Tokyo 168, Japan.
TELEPHONE: (03) 323-1111/TELEX: 232-2076

Printed in Japan (82710M19)

SCHEMATIC DIAGRAM

LAST	C ₆₀₀	C ₇₁₂	C ₆₀₂
R ₆₀₂	C ₆₀₁	C ₇₁₁	C ₆₀₃
R ₇₀₄	C ₇₁₂	C ₆₀₂	C ₆₀₃
R ₆₀₅	C ₆₀₂	C ₆₀₃	C ₆₀₃
R ₆₀₃	C ₆₀₃	C ₆₀₃	C ₆₀₃

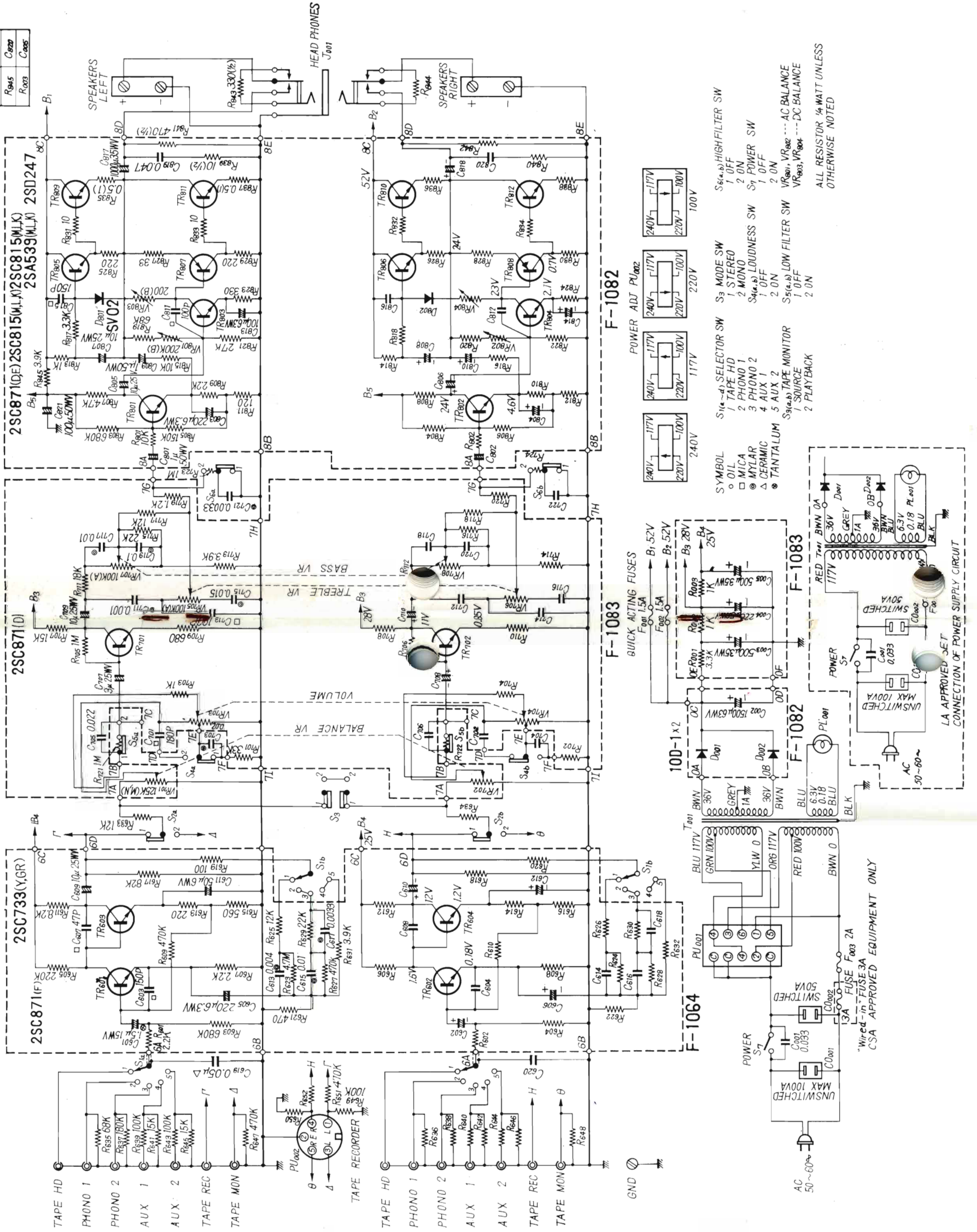

- SYMBOL**
 ○ OIL
 □ MICALP
 ⊠ MYLAR
 △ CERAMIC
 ● TANTALUM
- S_{1(a-d)} SELECTOR SW**
 1 TAPE HD
 2 PHONO 1
 3 PHONO 2
 4 AUX 1
 5 AUX 2
- S₂ MODE SW**
 1 STEREO
 2 MONO
- S_{3(a,b)} LOUDNESS SW**
 1 OFF
 2 ON
- S_{4(a,b)} LOW FILTER SW**
 1 OFF
 2 ON
- S_{5(a,b)} AC BALANCE**
 1 SOURCE
 2 PLAYBACK
- S_{6(a,b)} HIGH FILTER SW**
 1 OFF
 2 ON
- S₇ POWER SW**
 1 OFF
 2 ON
- VR₁₀₁, VR₁₀₂ --- AC BALANCE**
VR₁₀₃, VR₁₀₄ --- DC BALANCE
- ALL RESISTOR 1/4 WATT UNLESS OTHERWISE NOTED